

## Solution of $\text{TiO}_2$ memristor-capacitor series circuit excited by a constant voltage source and its application to calculate operation frequency of a programmable $\text{TiO}_2$ memristor-capacitor relaxation oscillator

Reşat MUTLU\*

Department of Electronics and Communication Engineering, Namık Kemal University, Çorlu Engineering Faculty, Çorlu, Tekirdağ, Turkey

Received: 16.08.2011

Accepted/Published Online: 23.11.2011

Printed: 28.08.2015

**Abstract:** The memristor is a new-found circuit element and its applications in programmable circuits are also under study. Analysis of most of its combinations with other circuit elements such as resistors, capacitors, and inductors does not exist. In this work, a  $\text{TiO}_2$  memristor model with linear dopant drift speed is used and the solution of a  $\text{TiO}_2$  memristor and capacitor series circuit driven by a constant voltage source is given. It is then used to analyze a novel M-C oscillator circuit. In previous programmable oscillator studies, the memristance of the oscillator was assumed to be constant. However, in this study, the analysis of the M-C oscillator is done considering time-varying memristance and using the solution of the  $\text{TiO}_2$  memristor and capacitor series circuit supplied by a constant voltage. In this work, a formula for calculation of the exact value of the M-C oscillator frequency is given. Minimum and maximum operation frequencies of the oscillator are also calculated.

**Key words:**  $\text{TiO}_2$  memristor, M-C series circuit, programmable oscillator, circuit theory

### 1. Introduction

The memristor is a newly discovered circuit element, which was theoretically predicted and claimed to be the fourth circuit element in 1971 [1]. It has a relationship between its flux, which is its voltage integration with respect to time, and its charge, which is its current integration with respect to time. Therefore, its voltage to current ratio is dependent on the charge that passes through it. It is called memristance and has the same unit as resistance [1]. A memristor is similar to a nonlinear resistor but it has a memory, which a nonlinear resistor does not have. For a long time, the memristor was regarded as a theoretical work or a mathematical curiosity, since no memristor was found. In 2008, an HP research team declared that they found a memristor in nanoscale made of  $\text{TiO}_2$  sandwiched between Pt contacts [2] and the memristor has become a new active research area. A review of memristors can be found in [3]. New kinds of memories can also be established using memristors. Analog applications of memristors are also under study [4–12]. Adjustable or programmable gain applications of memristors are inspected in [4–8]. Programmable oscillators, programmable Schmitt-trigger circuits, and programmable threshold comparators using memristors are also considered in [5]. The memristor is a new circuit component. Solutions of its combinations with other circuit components are not always readily available. In [12], some properties of memristors were explained. Series  $\text{TiO}_2$  memristor-capacitor circuits without a power supply were also analyzed in [12]. However, series  $\text{TiO}_2$  memristor-capacitor circuits with a

\*Correspondence: rmutlu@nku.edu.tr

constant voltage supply have not been analyzed in the literature yet. In this work, a solution is found and used to analyze a relaxation oscillator with a  $\text{TiO}_2$  memristor.

The paper is arranged as follows. In the second section, the  $\text{TiO}_2$  memristor model is given. In the third section, a series memristor-capacitor circuit with a DC supply is analyzed. In the fourth section, the solution is used to analyze a relaxation oscillator with a memristor. The results are summarized in the conclusion section.

## 2. Charge-dependent $\text{TiO}_2$ memristor

A memristor can be modeled as either charge- or flux-dependent [1]. In this work, the charge-dependent model of a  $\text{TiO}_2$  memristor with linear dopant drift speed is used. The memristor model given by the HP research team is linearly dependent on memristor charge [2] and their memristance formula is:

$$M(q) = R_{OFF} \left( 1 - \frac{\mu_V R_{ON}}{D^2} q(t) \right), \quad (1)$$

where  $R_{OFF}$  is the resistance if the memristor region were fully undoped,  $R_{ON}$  is the resistance if the memristor region were fully doped,  $D$  is the total length of the memristor, and  $\mu_V$  is the mobility of oxygen atoms in the memristor.

The memristor memristance can also be written as

$$M(q) = M_0 - Kq, \quad (2)$$

where  $M(q)$  is the memristor's memristance,  $M_0$  is the maximum memristance or the zero charge memristance,  $K$  is the memristance charge coefficient, and  $q$  is the memristance instantaneous charge.

If the memristor is saturated, its memristance is equal to

$$M_{sat} = M(q_{sat}) = M_0 - Kq_{sat}, \quad (3)$$

where  $q_{sat}$  is the saturation memristance charge.

If the memristor is not saturated,

$$M_0 \geq M(q) \geq M_{sat}. \quad (4)$$

Memristance charge is the integration of its current with respect to time and it is equal to

$$q(t) = \int_0^t i dt + q(0), \quad (5)$$

where  $q(0)$  is the initial charge of the memristor.

## 3. M-C series circuit with a constant voltage

Analysis of the memristor-capacitor series circuit driven by a constant voltage source is done in this section.

If a constant voltage is applied to memristor-capacitor series circuit,

$$V_M(t) + V_c(t) = V_{dc}, \quad (6)$$

$$(M_0 - Kq) i_M(t) + C \frac{dV_c(t)}{dt} = V_{dc}, \quad (7)$$

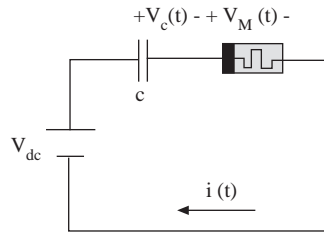

**Figure 1.** Memristor-capacitor series circuit with a constant voltage source.

$$(M_o - Kq) \frac{dq(t)}{dt} + \frac{q_c(t)}{C} = V_{dc}. \quad (8)$$

The memristor current is equal to the capacitor current:

$$i(t) = \frac{dq(t)}{dt} = \frac{dq_C(t)}{dt}. \quad (9)$$

Therefore, the following relationship can be written between the unsaturated memristor and capacitor charges:

$$q(t) = q_C(t) + B, \quad (10)$$

where B is the integration constant, which can be found from the initial conditions:

$$B = q(0) - q_C(0). \quad (11)$$

Using B, Eq. (8) turns into

$$(M_o - Kq) \frac{dq(t)}{dt} + \frac{q - B}{C} = V_{dc}. \quad (12)$$

Pulling out the current,

$$\frac{dq(t)}{dt} = \frac{V_{dc} - \frac{q_C(t) - B}{C}}{(M_o - Kq)} = \frac{CV_{dc} - q + B}{C(M_o - Kq)}. \quad (13)$$

Rearranging the differential equation,

$$\frac{dt}{C} = \frac{(M_o - Kq) dq}{CV_{dc} - q + B}, \quad (14)$$

$$\frac{dt}{C} = \frac{(M_o + K(-q + CV_{dc} + B - B - CV_{dc})) dq}{CV_{dc} - q + B}, \quad (15)$$

$$\frac{dt}{C} = \left( \frac{M_o - KB - KCV_{dc}}{CV_{dc} - q + B} + K \right) dq. \quad (16)$$

Taking the integration of both sides of Eq. (16),

$$\frac{t}{C} + A = \int \frac{M_o - KB - KCV_{dc}}{CV_{dc} - q + B} dq + Kq, \quad (17)$$

$$\frac{t}{C} + A = -(M_o - KB - KCV_{dc}) \ln(CV_{dc} - q + B) + Kq. \quad (18)$$

The integration constant A is found at t = 0:

$$A = -(M_o - KB - KCV_{dc}) \ln(CV_{dc} - q(0) + B) + Kq(0). \quad (19)$$

Therefore,

$$\frac{t}{C} = (M_o - KB - KCV_{dc}) \ln\left(\frac{CV_{dc} - q(0) + B}{CV_{dc} - q + B}\right) + K(q - q(0)), \quad (20)$$

$$t = C(M_o - KB - KCV_{dc}) \ln\left(\frac{CV_{dc} - q(0) + B}{CV_{dc} - q + B}\right) + KC(q - q(0)). \quad (21)$$

This is an implicit function with respect to time. The memristor gets saturated at time  $t_{sat}$ , which is equal to

$$t_{sat} = C(M_o - KB - KCV_{dc}) \ln\left(\frac{CV_{dc} - q(0) + B}{CV_{dc} - q_{sat} + B}\right) + KC(q_{sat} - q(0)). \quad (22)$$

It should be remembered that during saturation memristor charge is constant and equal to  $q_{sat}$ . During saturation, the memristor behaves as a resistor. If the memristor is under saturation, the capacitor voltage is equal to

$$V_c(t) = (V_c(t_{sat}) - V_{dc}) e^{-(t-t_{sat})/\tau} + V_{dc}. \quad (23)$$

The capacitor charge is found as

$$q_C(t) = CV_c(t) = C(V_c(t_{sat}) - V_{dc}) e^{-(t-t_{sat})/\tau} + CV_{dc}. \quad (24)$$

The memristor current or the capacitor current is

$$i = \frac{dq_C(t)}{dt} = \frac{(-V_c(t_{sat}) + V_{dc}) e^{-(t-t_{sat})/\tau}}{R}. \quad (25)$$

The memristor voltage is

$$V_C = M(q)i = \frac{M_{sat}(-V_c(t_{sat}) + V_{dc}) e^{-(t-t_{sat})/\tau}}{R}. \quad (26)$$

Even though the differential equation is solved, its solution is an implicit function. The nonlinear function can be evaluated numerically. For the circuit parameters given in Table 1, the circuit is simulated. The circuit current, the memristor charge, the capacitor charge, and the memristor voltage are shown in Figures 2-5.

**Table 1.** Circuit parameters.

Parameter	Value
$K$	900,000,000 $\Omega/C$
$M_O$	1500 $\Omega$
$q_{sat}$	1.5 $\mu C$
$C$	5.5556e-008 F
$V_C(0)$	0 V
$q(0)$	0 C
$V_{dc}$	10 V

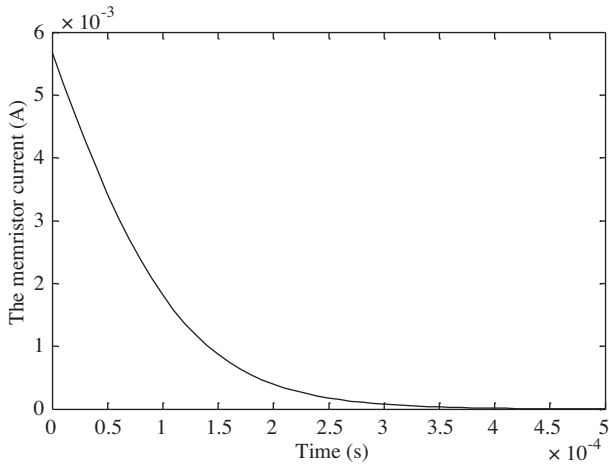

Figure 2. Circuit current.

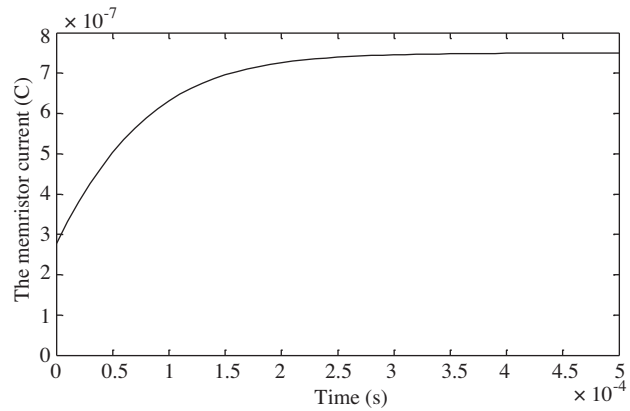

Figure 3. Capacitor charge.

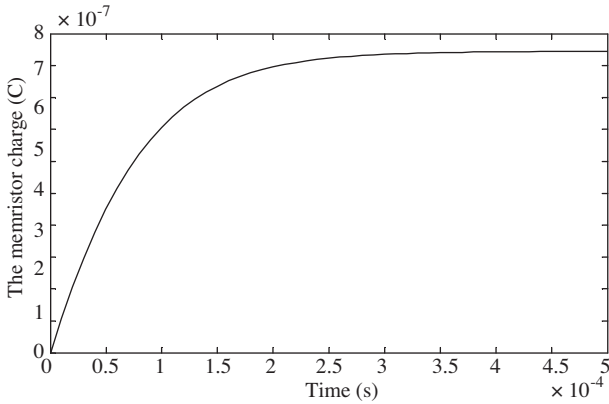

Figure 4. Memristor charge.

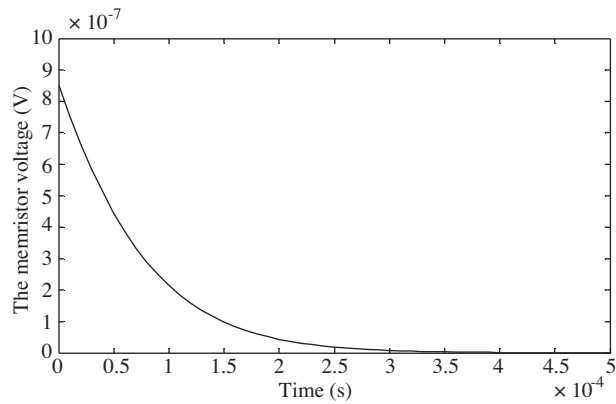

Figure 5. Memristor voltage.

#### 4. M-C oscillator with TiO<sub>2</sub> memristor

Relaxation oscillators are commonly used in electronics. An oscillator can be made with a memristor as an R-C oscillator. Replacing one of the resistors in Figure 6 would produce a memristor oscillator whose frequency can be adjusted by the value of the initial memristor charge. In [5], a programmable relaxation oscillator with a memristor was given. The oscillator of [5] is shown in Figure 7. In this paper, a different relaxation oscillator is made by placing the memristor in series with its capacitor as shown in Figure 8. Now the solution of the M-C series circuit can be used to analyze the relaxation oscillator. Although Eq. (21) is an implicit function, it helps us to find the exact solution of the frequency of the M-C oscillator given in Figure 8.

The M-C oscillator shown in Figure 8 would switch its output from positive saturation voltage to negative saturation voltage at  $t = T_e/2$ . Eq. (21) can be written also as a function of capacitor charge:

$$t = C (M_o - KB - KCV_{dc}) \ln \left( \frac{CV_{dc} - q_C(0)}{CV_{dc} - q_C} \right) + KC (q_C - q_C(0)). \quad (27)$$

Eq. (25) is a nonlinear function with respect to time. However, the oscillator frequency can still be calculated. At the end of first alternance, at  $t = T_e/2$ ,

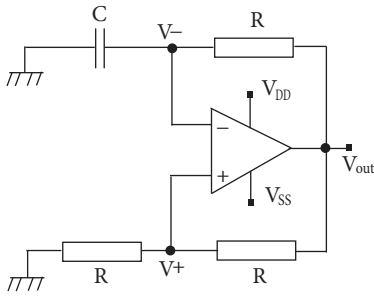

Figure 6. R-C oscillator circuit.

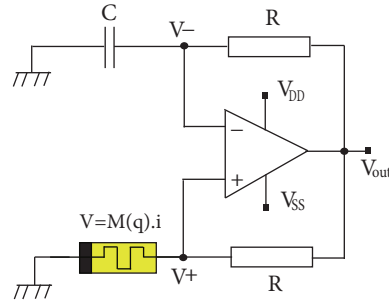

Figure 7. Programmable frequency M-C relaxation oscillator given in [5].

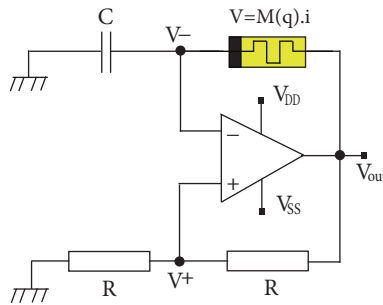

Figure 8. The new programmable frequency M-C relaxation oscillator.

$$\frac{T_e}{2} = C (M_o - KB - KCV_{dc}) \ln \left( \frac{CV_{dc} - q_C(0)}{CV_{dc} - q_C(T_e/2)} \right) + KC (q_C(T_e/2) - q_C(0)). \quad (28)$$

Also at  $t = T_e/2$ , capacitor charge  $q_c(T_e/2) = -q_c(0) = CV_{dc}/2$ . Using this, Eq. (28) can also be written as

$$\frac{T_e}{2} = C (M_o - KB - KCV_{dc}) \ln(3) + KC (CV_{dc}). \quad (29)$$

Then the frequency becomes

$$f_e = \frac{1}{T_e} = \frac{1}{(2C (M_o - KB - KCV_{dc}) \ln(3) + 2KC (CV_{dc}))}. \quad (30)$$

Using the initial memristor charge or Eq. (10),

$$f_e = \frac{1}{2C (M_o - K(q(0) - q_C(0)) - KCV_{dc}) \ln(3) + 2KC (CV_{dc})}, \quad (31)$$

or

$$f_e = \frac{1}{(M_o C - KC \cdot q(0) - 3/2 KC^2 V_{dc}) 2 \ln(3) + 2 KC^2 V_{dc}}. \quad (32)$$

Therefore, assuming that the memristor is not saturated, the oscillator frequency is found as a function of memristor parameters, capacitance, capacitor voltage, and memristor initial charge.

When  $K = 0$ , i.e. the memristor turns into a resistor with a value of  $M_o$ , and the oscillator frequency is

$$f_e = \frac{1}{2M_o C \ln(3)}. \quad (33)$$

Eq. (33) can be found in all books on operational amplifiers.

The change in memristor charge during oscillation is  $\Delta q$ .

$$\Delta q = q(T_e/2) - q(0) = CV_{dc}. \quad (34)$$

If the memristor is not saturated, the maximum oscillator frequency is obtained by making the initial memristor charge equal to zero. Then the maximum oscillator frequency is:

$$f_{\max} = \frac{1}{(M_o C - 3/2KC^2V_{dc}) 2\ln(3) + 2KC^2V_{dc}}. \quad (35)$$

If the memristor is not saturated, the minimum oscillator frequency is obtained by making the initial memristor charge equal to the maximum memristor charge,  $q_{sat}$ . In this case,

$$q(T_e/2) = q_{sat} \text{ and } q(0) = q_{sat} - CV_{dc}. \quad (36)$$

Then the minimum oscillator frequency is:

$$f_{\min} = \frac{1}{(M_o C - KC(q_{sat} - CV_{dc}) - 3/2KC^2V_{dc}) 2\ln(3) + 2KC^2V_{dc}}. \quad (37)$$

Therefore, when the memristor is saturated at  $q = q_{sat}$ , the formulas are not valid anymore. Numeric methods must be employed for the solution of operation frequency.

Additionally, if we describe an effective memristance (or resistance) to make Eq. (32) similar to Eq. (33),

$$M_{eff} = (M_o - K \cdot q(0) - 3/2KC^2V_{dc}) \ln(3) + KC^2V_{dc} / \ln(3). \quad (38)$$

Eq. (32) can also be written as

$$f_e = \frac{1}{2M_{eff} C \ln(3)}. \quad (39)$$

The effective memristance depends not only on the memristor parameters and the initial memristor charge but also on the capacitance and the saturation voltage of the opamp. The memristor of the oscillator is prevented from going into saturation. Oscillator frequency is drawn for the given circuit parameters in Tables 1 and 2 as shown in Figure 9. Since the memristor's memristance value can only take values between  $M_o$  and  $M_{sat}$ , the frequency can only take values between the minimum and maximum operation frequencies. The curve shown in Figure 9 is not available below the minimum frequency or above the maximum frequency. The domain of the oscillator operation frequency is

$$f_{\min} \leq f_e \leq f_{\max}. \quad (40)$$

The oscillator is simulated for  $q(0) = 0$  and the parameters given in Tables 1 and 2. Its waveforms are shown in Figures 10–17.

**Table 2.** Circuit parameters.

$V_{dc}$	13.5 V
R	20 k $\Omega$

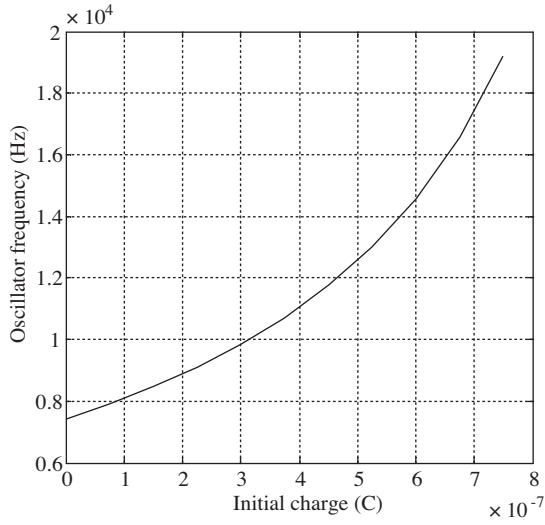

**Figure 9.** The frequency of relaxation oscillator vs. initial charge.

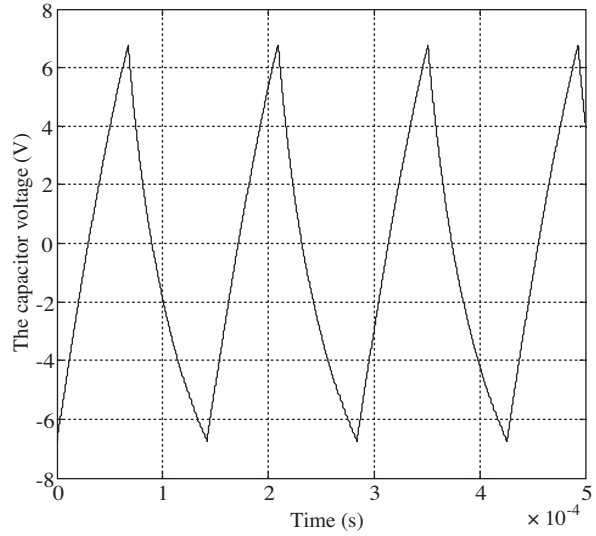

**Figure 10.** The capacitor voltage vs. time.

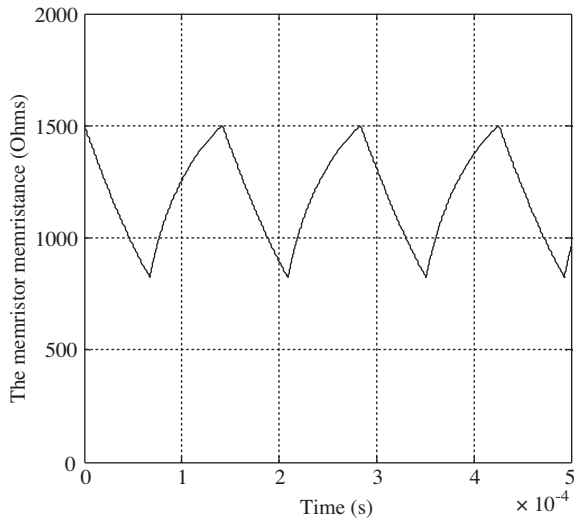

**Figure 11.** The memristor's memristance voltage vs. time.

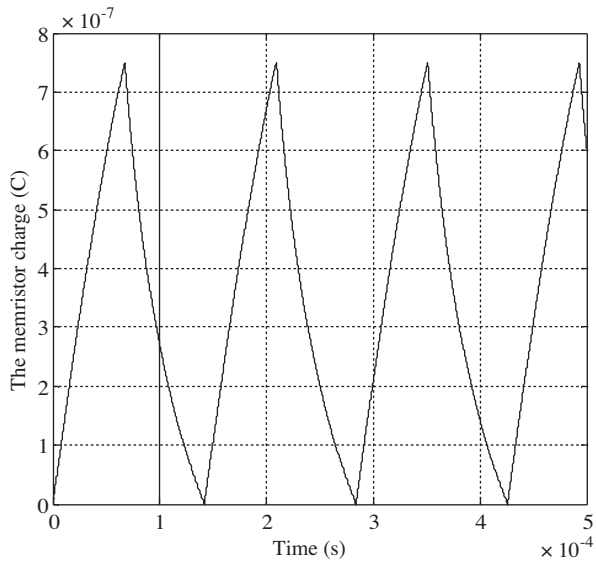

**Figure 12.** The memristor charge vs. time.

### 5. Conclusion

An M-C series circuit with TiO<sub>2</sub> memristor driven by a constant voltage source is analyzed. An implicit function is found for memristor charge or capacitor charge versus time. The implicit function is evaluated



numerically to find currents and voltages of the circuit elements and the memristor charge. It is also shown here that the solution can be used to analyze an M-C relaxation oscillator. A more detailed analysis of the M-C oscillator should also be done in the future. The M-C series circuit solution may also find usage in analyzing different types of nonlinear oscillator circuits having M-C series circuits in the future. For a nonlinear element like a memristor, it is important to have exact solutions as those solutions of combinations of the linear circuit elements such as R-C, R-L, L-C, R-L-C, etc. already exist. Memristor combinations with the linear circuit elements M-R, M-C, M-L, etc. for different types of sources and connections should also be analyzed in detail so that the memristor, the new circuit element, can be used to the full extent.

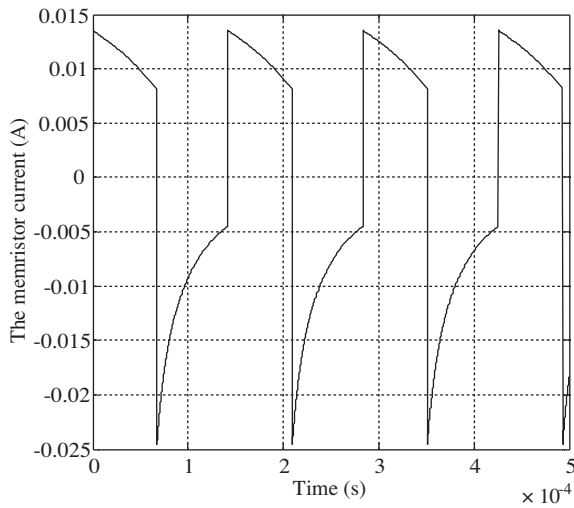

Figure 13. The memristor current vs. time.

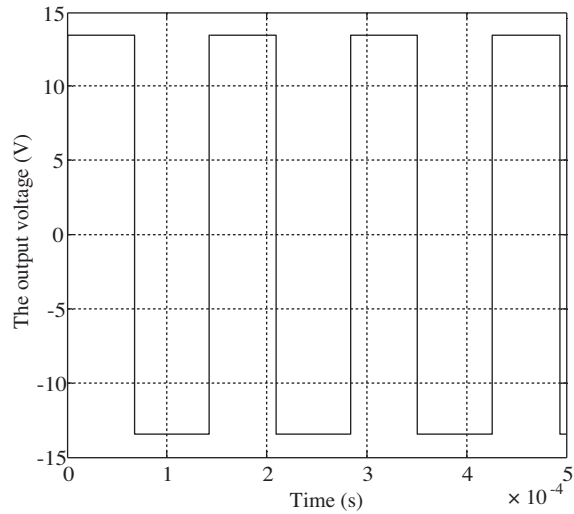

Figure 14. The Output voltage vs. time.

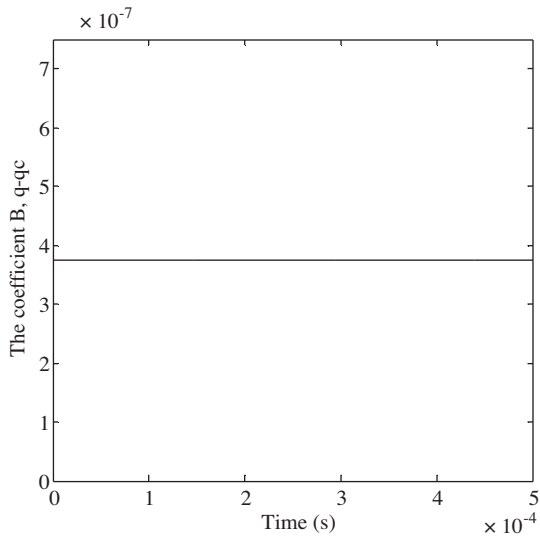

Figure 15. The coefficient B, which is the difference between the memristor charge and the capacitor charge vs. time.

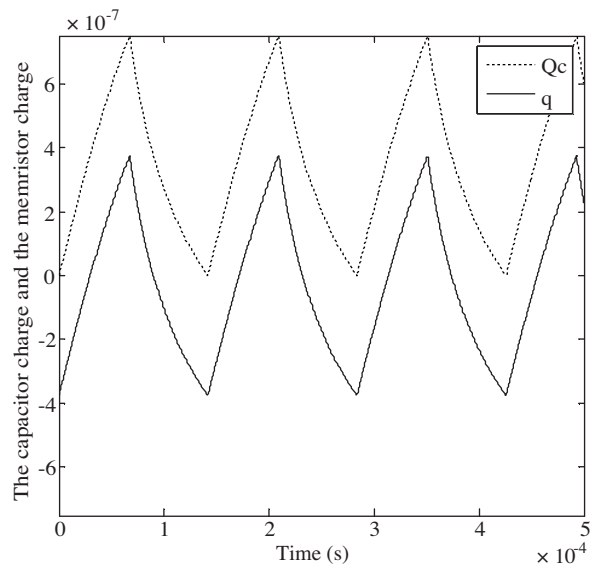
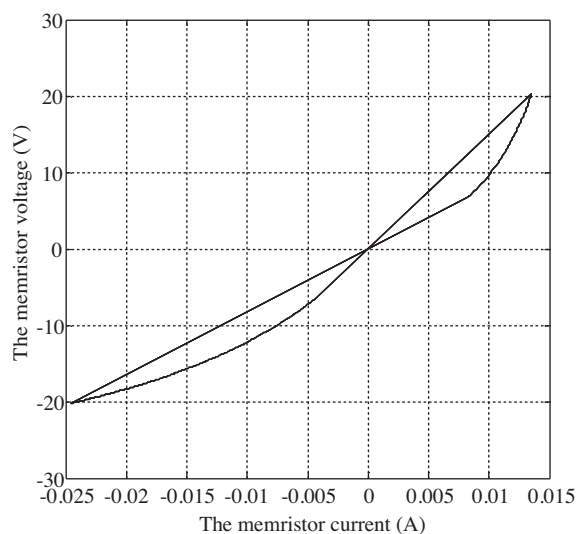

Figure 16. The memristor charge and the capacitor charge vs. time.



**Figure 17.** The memristor voltage vs. the memristor current.

There is not much information about the effects of process and temperature variations on  $\text{TiO}_2$  memristors available in the literature [13–20]. When more data on  $\text{TiO}_2$  memristors become available, their effects on oscillator performance can also be inspected using the M-C oscillator analysis given here.

### References

- [1] L.O. Chua, “Memristor - the missing circuit element”, *IEEE Transactions on Circuit Theory*, Vol. 18, pp. 507–519, 1971.
- [2] D.B. Strukov, G.S. Snider, D.R. Stewart, R.S. Williams, “The missing memristor found”, *Nature (London)*, Vol. 453, pp. 80–83, 2008.
- [3] O. Kavehei, A. Iqbal, Y.S. Kim, K. Eshraghian, S.F. Al-Sarawi, D. Abbott, “The fourth element: characteristics, modelling and electromagnetic theory of the memristor”, *Proceedings of the Royal Society of London A*, Vol. 466, pp. 2175–2202, 2010.
- [4] T.A. Wey, W.D. Jemison, “An automatic gain control circuit with  $\text{TiO}_2$  memristor variable gain amplifier”, in 2010 8th IEEE International NEWCAS Conference (NEWCAS), pp. 49–52, 2010.
- [5] Y.V. Pershin, M. Di Ventra, “Practical approach to programmable analog circuits with memristors”, *IEEE Transactions on Circuits and Systems I: Regular Papers*, Vol. 57, pp. 1857–1864, 2010.
- [6] S. Shin, K. Kim, S.M. Kang, “Memristor-based fine resolution programmable resistance and its applications”, in ICCAS 2009 International Conference on Communications, Circuits and Systems, pp. 948–951, 2009.
- [7] S. Shin, K. Kim, S.M. Kang, “Memristor applications for programmable analog ICs,” *IEEE Transactions on Nanotechnology*, Vol. 10, pp. 266–274, 2011.
- [8] T.A. Wey, W.D. Jemison, “Variable gain amplifier circuit using titanium dioxide memristors”, *IET Circuits, Devices & Systems*, Vol. 5, pp. 59–65, 2011.
- [9] Q. Yu, Z. Qin, J. Yu, Y. Mao, “Transmission characteristics study of memristors based Op-amp circuits”, in ICCAS 2009 International Conference on Communications, Circuits, and Systems, pp. 974–977, 2009.
- [10] A. Delgado, “The memristor as controller”, in IEEE Nanotechnology Materials and Devices Conference (NMDC), pp. 376–379, 2010.
- [11] X. Wang, Y. Zhao, Y. Liao, “Dynamic performance analysis of PID controller with one memristor”, in 2011 International Conference on Information Science and Technology (ICIST), pp. 1234–1237, 2011.

- [12] Y.N. Joglekar, S.J. Wolf, “The elusive memristor: properties of basic electrical circuits”, *European Journal of Physics*, Vol. 30, pp. 661–675, 2009.
- [13] Y. Chen, X. Wang, “Compact modeling and corner analysis of spintronic memristor”, in *NANOARCH '09, IEEE/ACM International Symposium on Nanoscale Architectures*, pp. 7–12, 2009.
- [14] K.H. Jo, C.M. Jung, K.S. Min, S.M. Kang, “Self-adaptive write circuit for low-power and variation-tolerant memristors”, *IEEE Transactions on Nanotechnology*, Vol. 9, pp. 675–678, 2010.
- [15] H. Manem, G.S. Rose, X. He, W. Wang, “Design considerations for variation tolerant multilevel CMOS/nano memristor memory”, in *GLSVLSI '10, Proceedings of the 20th Symposium on VLSI*.
- [16] D. Niu, Y. Chen, C. Xu, Y. Xie, “Impact of process variations on emerging memristor”, in *2010 47th ACM/IEEE Design Automation Conference (DAC)*, pp. 877–882, 2010.
- [17] J. Rajendran, H. Maenm, R. Karri, G.S. Rose, “An approach to tolerate process related variations in memristor-based applications”, in *2011 24th International Conference on VLSI Design*, pp.18–23, 2011.
- [18] M. Hu, H. Li, Y. Chen, X. Wang, R.E. Pino, “Geometry variations analysis of TiO<sub>2</sub> thin-film and spintronic memristors”, in *Proceedings of the 16th Asia and South Pacific Design Automation Conference*, pp. 25–30, 2011.
- [19] F. Alibart, L. Gao, B. Hoskins, D. Strukov, “High-precision tuning of state for memristive devices by adaptable variation-tolerant algorithm”, *Nanotechnology*, Vol. 23, p. 075201, 2012.
- [20] S.E. Savel'ev, A.S. Alexandrov, A.M. Bratkovsky, R.S. Williams, “Molecular dynamics simulations of oxide memristors: thermal effects”, *Applied Physics A: Materials Science & Processing*, Vol. 102, pp. 891–895, 2011.