



## Demonstration of Synaptic Connections with Unipolar Junction Transistor based Neuron Emulators

İ. Devocioğlu<sup>a</sup>, Ş. Ç. Yener<sup>\*b,c</sup>, R. Mutlu<sup>d</sup>

<sup>a</sup> Department of Biomedical Engineering, Tekirdag Namik Kemal University, Tekirdag, Turkey

<sup>b</sup> Department of Electrical and Electronics Engineering, Sakarya University, Sakarya, Turkey

<sup>c</sup> Electromagnetic Research Center, Sakarya University, Sakarya, Turkey

<sup>d</sup> Department of Electronics and Telecommunication Engineering, Tekirdag Namik Kemal University, Tekirdag, Turkey

### PAPER INFO

#### Paper history:

Received 20 October 2019

Received in revised form 02 September 2020

Accepted 03 September 2020

#### Keywords:

Unipolar Junction Transistor

Neuron Emulators

Artificial Neurons

Biomedical Engineering Education

### ABSTRACT

Neuron emulator circuits can be used for teaching and proving concepts. Such emulators should be made with cheap and off-the-shelf components. There are bipolar and MOSFET transistor-based neuron emulator circuits heavily used in literature. Opamp-based neuron emulators are also commonly used. Such circuits provide simple and cheap solution instead of using microcontroller-based neuron emulators if many neurons are to be used in the studies such as showing circadian resonance. Unipolar junction transistor (UJT) is commonly used in industrial electronics applications. It provides a cheap timing circuit. Although there are a few UJT-based artificial neuron patents, we were unable to find research articles on UJT-based artificial neurons. In this study, we examined a simple network of UJT-based artificial neurons and show their spiking and bursting behavior with synaptic connections between neurons. It is shown that the firing rate of a UJT-neuron can be increased by utilizing spikes generated by another one with simulations. This behavior represents excitatory connectivity between two neurons.

doi: 10.5829/ije.2020.33.11b.10

### NOMENCLATURE

$R$	Resistor	$C$	Capacitor
$\eta$	Intrinsic stand-off ratio of an UJT	$B_1, B_2$	Biases of UJT
$V$	Voltage	$E$	Emitter of UJT
$f$	Frequency	$V_{TH}$	Emitter threshold of UJT

## 1. INTRODUCTION

Hudgkin-Huxley neuron model have resulted in a Nobel prize [1, 2]. This model is quite complex to emulate with electronic circuits and that's why simplified neuron models are commonly used in artificial neural network studies [3, 4]. Fitzhugh-Nagumo model is a simplified neuron model whose circuit emulator is the first made historically [5, 6]. Neuron emulators are commonly used in neuroscience for education and studies [7-13]. As public awareness increases in life sciences, demand for easy-to-build and low-cost tools increases.

A unijunction transistor (UJT) is a three-terminal, semiconductor device which shows negative resistance and switching characteristics for use as a relaxation oscillator in phase control applications. Unipolar junction transistor is a commonly used component in triggering circuits of industrial electronics applications. They provide cheap timing circuits. There are a few UJT-based artificial neuron patents [14, 15]. In addition, some recent papers are presenting UJT-based neuron models where other transistor types were also used [16, 17]. Although these models generate action potentials very similar to a real neuron, their structure is complex (i.e. inductors were used) and how the inhibitory neurons could be built

\*Corresponding Author Institutional Email: syener@sakarya.edu.tr  
(Ş. Ç. Yener)

is not clear. It is important to show that a UJT-based neuron emulator circuit can be made using cheap and off-the-shelf circuit components. In this manner, how ensembles of neurons work together can be shown and experimented in low-budget laboratory environments. Furthermore, we aimed to provide simpler circuit structures for easier analyses and further experimentations on artificial neural networks on devices with low specifications. They have the potential to be used in system control [18].

In this study, we examined a UJT-based artificial neuron and show that it can produce spikes as well as receiving synaptic inputs. First, a UJT-based artificial neuron circuit is given, its operation is explained, and, using simulations, its spiking behavior is demonstrated. A single neuron may encode different sensory inputs, but neural systems mostly depend on the activity of an ensemble of neurons connected via synapses. Therefore, a neural emulator needs to demonstrate a synaptic connection between neural units in a plain concept. Using UJT-based neurons, excitatory or inhibitory neurons can be mimicked with a simple modification in the circuit. We simulated an excitatory synapse between two UJT-based neurons in OrCAD PSpice. The proposed neuron and synaptic connection models can be used for educational purposes when implemented in emulators.

This article is organized as follows. A brief introduction to UJT is made in the second section. A UJT-based neuron model is given and its operation is explained in the third section. The simulation results are given in the fourth section. The article is finished with the conclusion section.

## 2. UNIUNCTION TRANSISTOR

Unijunction Transistor symbol is shown in Figure 1a. It has three legs designated as  $B_1$ ,  $B_2$ , and E. It is made of p and n type regions and it has only one p-n junction shown in Figure 1b. It has a different characteristic than Bipolar junction transistors (BJTs). They are not used to amplify signals like BJTs and MOSFETs. A simplified internal circuit model and circuit symbol of a UJT is given in Figure 1c. The diode models the p-n junction formed between the heavily doped p region (E) and the lightly doped n-type region and  $R_{BB1}$  and  $R_{BB2}$  resistors model the channel resistances of the n-type regions from the junction to bases  $B_1$  and  $B_2$  respectively. shown in the equivalent circuit. The UJTs have negative resistance property which results in their usage in triggering or timer circuits Its equivalent circuit is given in Figure 1c. Its emitter current- emitter voltage characteristic is depicted in Figure 2 and the intrinsic stand-off ratio of a UJT transistor which is used to calculate its firing frequency in oscillator applications is given as:

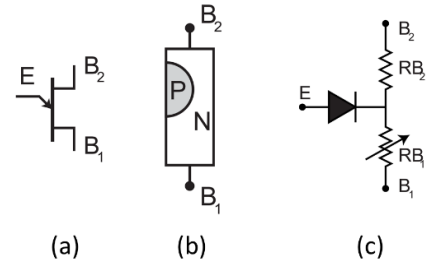

**Figure 1.** (a) UJT symbol (b) UJT topology and (c) UJT equivalent circuit

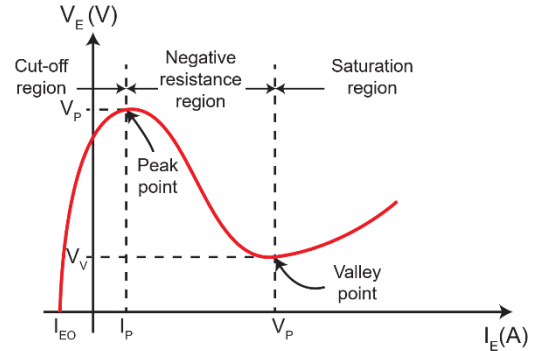

**Figure 2.** Static emitter current-voltage characteristic for a Unijunction Transistor

$$\eta = R_{BB1} / (R_{BB1} + R_{BB2}) \quad (1)$$

where  $R_{BB1}$  and  $R_{BB2}$  base resistors. Typical values of  $\eta$  range from 0.4 to 0.8 for most common UJT's. The emitter threshold voltage of a UJT transistor with a silicon p-n junction called the firing voltage of UJT is given as:

$$V_{TH} = \eta V_{BB1-BB2} + V_D = \eta V_{BB1-BB2} + 0.7 \quad (2)$$

This is the minimum value of the emitter voltage  $V_E$  for which current starts flowing through the emitter. As  $V_E$  increases, so does the emitter current  $I_E$ . When  $V_E$  increases to a particular point called the peak voltage  $V_P$ . At this point, a significant amount of  $I_E$  flows and a substantial number of holes are injected into the junction.

These holes are attracted by  $B_1$  and repelled by  $B_2$ . Consequently, the region between E and  $B_1$  terminal gets saturated by injected holes, and the electrical conductivity of this region increases. This increased conductivity reduces  $R_{BB1}$  and  $\eta$ . This results in a situation where  $I_E$  increases and  $V_E$  decreases. This condition is similar to a negative resistance scenario. In Figure 2, it can be seen that, If the emitter voltage reaches  $V_P$ , it starts operating in negative resistance region and its voltage falls to  $V_F$ . The curve between  $V_P$  and  $V_V$  (valley voltage) has a negative slope. This negative resistance characteristic makes the UJT employed in relaxation oscillators and in triggering circuits. Finally,  $I_E$  gets

increased to a point that no more increase in electrical conductivity is possible. This point is called the “Valley point”. The emitter current at valley point is represented as  $I_V$ . Beyond the valley point, the UJT is under complete saturation and the junction acts as a fully saturated p-n junction. When the breakdown occurs, The UJT resistance between  $B_1$  and E falls from  $R_{BB1}$  down to  $R_{BB1sat}$ . That’s why the  $R_{BB1}$  is shown as a potentiometer.

### 3. UNIUNCTION TRANSISTOR-BASED NEURON EMULATOR

A commonly used UJT-based relaxation oscillator is shown in Figure 3. This UJT transistor-based neuron emulator circuit used also in this paper. It is made of one UJT, three resistors, and a capacitor. More information about UJT and its usage in triggering circuits can be found in textbooks [19, 20]. Its frequency is determined by  $R_3$  and C with Equation (3).

$$f = 1 / (R_3 C \ln(1 / (1 - \eta))) \tag{3}$$

The UJT transistor-based neurons used in this paper are similar to those shown in Figure 4. It is simulated in OrCAD PSpice and the neuron emulator waveforms are shown in Figure 5.

We aimed to model synaptic connections between different UJT-neurons in a simplified context, rather than firing behavior of a single UJT-neuron. Therefore, we preferred a plain version of the UJT-neuron compared to [15].

### 4. SIMULATION RESULTS OF TWO NEURONS WITH SYNAPTIC CONNECTION

In this section, we used the emulator circuit given in the previous section to show the synaptic connection between two neurons. The circuit is given in Figure 6 to show how a synaptic connection can be modeled between two neurons. The circuit has two UJTs, each one of which

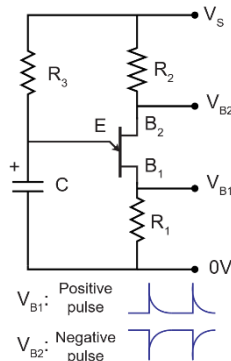

Figure 3. UJT-based relaxation oscillator

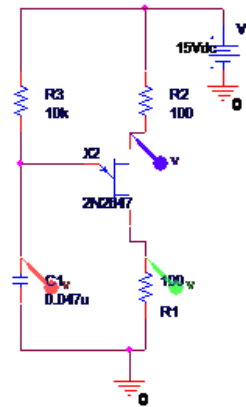

Figure 4. Neuron emulator circuit schematic drawn in OrCAD SPice

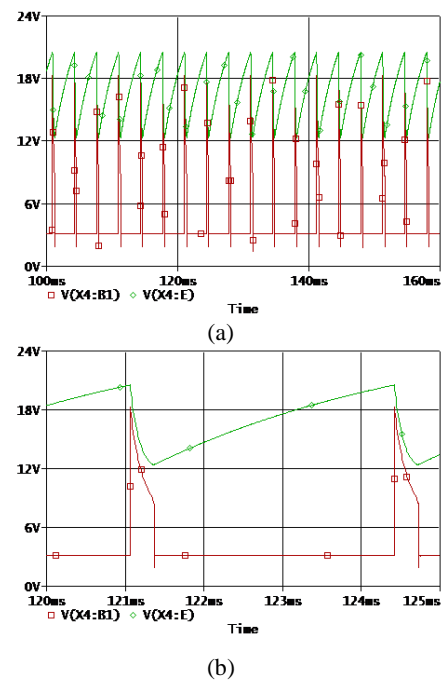

Figure 5. Neuron emulator waveforms. (a) The voltages of the capacitor and the resistor R1 vs. time (b) Zoomed the voltages of the capacitor and the resistor R1 vs. time

is used for making a neuron unit. The neurons are called U1 (the left one, also called a presynaptic neuron) and U2 (the right one, also called a postsynaptic neuron). The synaptic connection between two neurons is modeled with a resistor (R11) connecting the output of the first unit to the emitter of the next unit. A diode is used to ensure the connection is one-way. The Neuron Emulators are made of the components given in Table 1. The simulated waveforms are shown in Figure 7 (U1: red traces, U2: green traces). If the neuron circuits were in isolation, they would fire independently. However, here, they are connected through the resistor R11 which lets

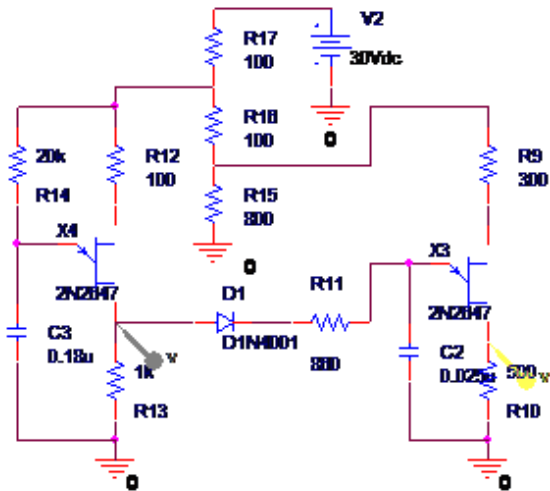

Figure 6. UJT-based two neurons with a synapse

TABLE 1. The Component Values of the Circuit Shown in Figure 6

Components	
Resistors	R9=300 Ω, R10=500 Ω, R11=860 Ω, R12=100 Ω, R13=1 KΩ, R14=20 KΩ, R15=800 Ω, R16=100 Ω, and R17=100, Ω
Capacitors	C2=0.025 uF and C3=0.18 uF
Diode	1N4001
UJTs	2N2647
Source	V2=30 V

them interact. The first one’s frequency is not affected much although the second one U2 is also fed by the first one. The firing frequency of the second one is affected by the first one. Both of the neurons are fed by the same voltage source  $V_{cc}$ . The second one is fed by a lower voltage from the source  $V_{cc}$  using a voltage divider shown in Figure 7. The neuron circuit U1 is fed with a higher voltage than U2.

Figure 7a–e shows the results of the simulation for different synaptic weights between two neurons considering R11 as 100 MΩ, 5kΩ, 1.5kΩ, 100Ω, and 0 Ω, respectively. For modeling a very weak synaptic connection (e.g. U2 receives minimum synaptic input from U1), we had chosen a very high R11 (100 MΩ, i.e. almost open-circuit case) (Figure 7a). In this case, although U1 fired at its predefined rate, U2 didn’t generate any spikes. This is because C2 is charging through a very high R11 with a spike-like voltage input which prevents U2 to reach its threshold and generate a spike. As the synaptic strength increases (by decreasing R11), the firing rate of U2 increases while U1 continues to generate spikes at its predefined rate (Figure 7b-d). By decreasing R11, C2 is charging at a higher rate, and as a

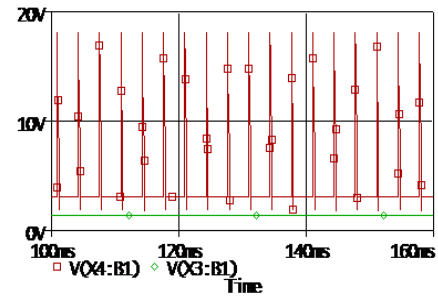

(a)

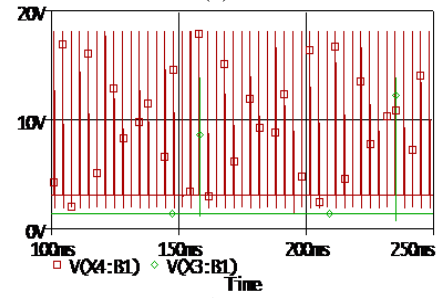

(b)

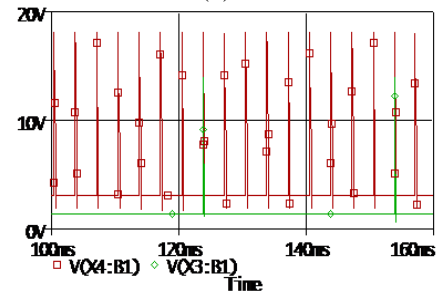

(c)

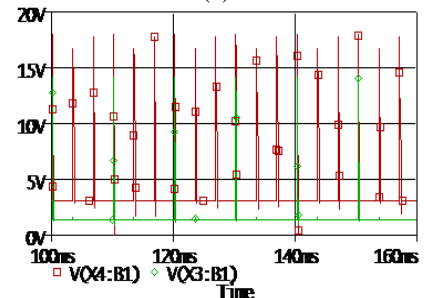

(d)

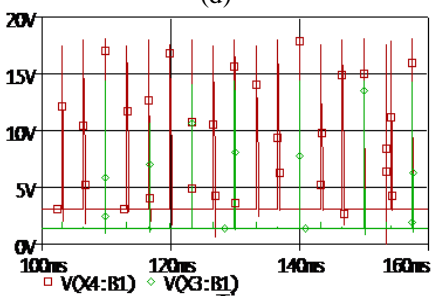

(e)

Figure 7. Effect of R11 which represents the synaptic coupling between U1 and U2. Synaptic connection increases from (a) to (e) (i.e. R11 decreases: 100MΩ, 5kΩ, 1.5kΩ, 100Ω and 0Ω). Red traces are for U1 and green traces are for U2

result, U2 is more likely to generate spikes. For example, if R11 is chosen  $5k\Omega$ , then U2 generates 1 spike for every 22 spikes of U1. In other words, after U1 fired 22 spikes, C2 charged to the threshold of U2 and made U2 fire a spike. If synaptic strength is increased by, for example, choosing R11  $100\Omega$ , then U2 fires at 1/3 rate of U1. In this case, C2 charged at a higher rate due to lower R11, so the firing rate of U2 increased. If R11 is chosen very small (i.e. it is shorted), which represents a very strong synaptic connection (i.e. saturated), then U2 generates spikes for every 2 or 3 spikes of U1 (Figure 7e). In this case, every spike generated by U1 directly charged C2 without R11, which is shorted. Therefore, higher firing rates were expected for U2 compared to the cases where R11 was not shorted. However, since the duration of spike pulses generated by U1 are so short that charging of C2 still takes some time (i.e. 2 or 3 spikes of U1) even when R11 was shorted. Therefore, this condition indicates a saturated synaptic coupling between two neurons. Overall, these results confirm our simplistic synapse model in UJT-based neurons.

The proposed UJT-based neuron and synaptic connection models are designed to be built with off-the-shelf components at a low cost. The models proposed by Tagluk [16] and Tagluk and Isik [17] consist of a voltage variable resistor (for synaptic connection), two capacitors, three resistors, one UJT, one BJT, and one DC source [17, 18]. The excitation of the neuron model was achieved with an AC source. Two units were coupled with a series of RLC circuits to mimic the axonal behavior of the neuron. In the current study, we used a simpler version of the neuron model which consisted of three resistors, one capacitor, one UJT, and one DC source. The synaptic coupling between two units was achieved with a diode and a resistor. Although the behavior of the former model is more realistic, it is harder to implement. The UJT-based neuron emulator and synaptic connection model proposed here can be used as an easy-to-demonstrate education material in low-budget laboratories. Furthermore, since the model had a minimum number of components, a more complex ensemble of neurons can be easily simulated on computers with low specifications or built on protoboards.

## 5. CONCLUSION

In this study, it is shown that a UJT-based neuron emulator circuit with a synaptic connection can be made using cheap off-the-shelf components easily. We demonstrated the firing rate of a UJT-neuron can be increased by utilizing spikes generated by another one with simulations made in OrCAD PSpice. This behavior represents excitatory connectivity between two neurons. Similarly, inhibitory connections can also be built using

UJT-neurons which would generate spikes with a negative voltage. If this neuron is connected to another unit as shown in Figure 6 (with an inversed diode direction), its negative spikes would discharge the capacitor of the postsynaptic neuron. As a result, the postsynaptic neurons firing period would elongate (i.e. firing rate would decrease). Due to space considerations, this is not shown in this paper. It is also possible to connect more than two UJT-neurons to a single postsynaptic unit via different resistors. The UJT-based neuron emulators would help teach neuroscience and biomedical engineering. They can also be improved by using VLSI circuits and used for neural studies.

## 6. REFERENCES

- Hodgkin, A.L. and Huxley, A.F., "A quantitative description of membrane current and its application to conduction and excitation in nerve", *The Journal of Physiology*, Vol. 117, No. 4, (1952), 500. doi: 10.1113/jphysiol.1952.sp004764
- FitzHugh, R., "Mathematical models of threshold phenomena in the nerve membrane", *The Bulletin of Mathematical Biophysics*, Vol. 17, No. 4, (1955), 257-278.
- Izhikevich, E.M., "Which model to use for cortical spiking neurons?", *IEEE Transactions on Neural Networks*, Vol. 15, No. 5, (2004), 1063-1070. doi: 10.1109/TNN.2004.832719
- Izhikevich, E.M. and Hoppensteadt, F., "Classification of bursting mappings", *International Journal of Bifurcation and Chaos*, Vol. 14, No. 11, (2004), 3847-3854. doi: 10.1142/S0218127404011739
- Nagumo, J., Arimoto, S. and Yoshizawa, S., "An active pulse transmission line simulating nerve axon", *Proceedings of the IRE*, Vol. 50, No. 10, (1962), 2061-2070. doi: 10.1109/JRPROC.1962.288235
- FitzHugh, R., "Impulses and physiological states in theoretical models of nerve membrane", *Biophysical Journal*, Vol. 1, No. 6, (1961), 445. doi: 10.1016/s0006-3495(61)86902-6
- Gonzales, O.A., Han, G., De Gyvez, J.P. and Sánchez-Sinencio, E., "Lorenz-based chaotic cryptosystem: A monolithic implementation", *IEEE Transactions on Circuits and Systems I: Fundamental Theory and Applications*, Vol. 47, No. 8, (2000), 1243-1247. doi: 10.1109/81.873879
- Linares-Barranco, B., Sánchez-Sinencio, E., Rodríguez-Vázquez, A. and Huertas, J.L., "A cmos implementation of fitzhugh-nagumo neuron model", *IEEE Journal of Solid-State Circuits*, Vol. 26, No. 7, (1991), 956-965. doi: 10.1109/4.92015
- Rajasekar, S., Murali, K. and Lakshmanan, M., "Control of chaos by nonfeedback methods in a simple electronic circuit system and the fitzhugh-nagumo equation", *Chaos, Solitons & Fractals*, Vol. 8, No. 9, (1997), 1545-1558. doi: 10.1016/S0960-0779(96)00154-3
- Tamaševičiūtė, E. and Mykolaitis, G., "Analogue modelling an array of the fitzhugh-nagumo oscillators", *Nonlinear Analysis: Modelling and Control*, Vol. 17, No. 1, (2012), 118-125. doi: 10.15388/NA.17.1.14082
- Zhao, J. and Kim, Y.-B., "Circuit implementation of fitzhugh-nagumo neuron model using field programmable analog arrays", in 2007 50th Midwest Symposium on Circuits and Systems, IEEE. (2007), 772-775. doi: 10.1109/MWSCAS.2007.4488691
- Petrovas, A., Lisauskas, S. and Slepikas, A., "Electronic model of fitzhugh-nagumo neuron", *Elektronika Ir Elektrotechnika*, Vol.

- 122, No. 6, (2012), 117-120. doi: 10.5755/j01.eee.122.6.1835
13. Tamaševičius, A., Bumelienė, S., Mykolaitis, G., Tamaševičiūtė, E. and Kirvaitis, R., "Desynchronization of mean-field coupled oscillators by remote virtual grounding", in 18th IEEE Workshop on Nonlinear Dynamics of Electronic Systems (NDES'2010).–Dresden, Germany. (2010), 30-33.
  14. Putzrath, F.L., *Processing apparatus utilizing simulated neurons*. 1965, Google Patents.
  15. Askew, W.J., *Unijunction transistor artificial neuron*. 1972, Google Patents.
  16. Tağluk, M.E., "A new dynamic electronic model of neuron's membrane", *Anatolian Science-Bilgisayar Bilimleri Dergisi*, Vol. 3, No. 1, (2018), 1-6.
  17. Tağluk, M.E. and Isik, I., "Communication in nano devices: Electronic based biophysical model of a neuron", *Nano Communication Networks*, Vol. 19, (2019), 134-147. doi: 10.1016/j.nancom.2019.01.006
  18. Chaturvedi, D., Malik, O. and Kalra, P., "Studies with a generalized neuron based pss on a multi-machine power system", (2004).
  19. Boylestad, R.L. and Nashelsky, L., "Electronic devices and circuit theory, Prentice Hall, (2012).
  20. Chitode, J., "Power electronics, Technical publications, (2009).

---

### Persian Abstract

---

#### چکیده

از مدارهای شبیه ساز نوروں می توان برای آموزش و اثبات مفاهیم استفاده کرد. چنین شبیه سازهایی باید با اجزای ارزان و خارج از قفسه ساخته شوند. مدارهای شبیه ساز نوروں مبتنی بر ترانزیستور دو قطبی و MOSFET وجود دارد که به شدت در ادبیات استفاده می شود. از شبیه سازهای عصبی مبتنی بر Opamp نیز معمولاً استفاده می شود. در صورت استفاده از بسیاری از سلولهای عصبی در مطالعاتی مانند نمایش رزونانس شبانه روزی، از چنین مدارهایی به جای استفاده از شبیه سازهای عصبی مبتنی بر میکروکنترلر، راه حل ساده و ارزان ارائه می شود. ترانزیستور اتصال تک قطبی (UJT) معمولاً در کاربردهای الکترونیک صنعتی استفاده می شود. این یک مدار زمان بندی ارزان را فراهم می کند. اگرچه چند حق ثبت اختراع نوروں مصنوعی مبتنی بر UJT وجود دارد، ما قادر به یافتن مقالات تحقیقاتی در مورد نوروں های مصنوعی مبتنی بر UJT نبودیم. در این مطالعه، ما یک شبکه ساده از سلولهای عصبی مصنوعی مبتنی بر UJT را بررسی کردیم و رفتار جهشی و ترکیبگی آنها را با اتصالات سیناپسی بین سلولهای عصبی نشان دادیم. قابل ذکر است که می توان با استفاده از سنبله های تولید شده توسط دیگری با شبیه سازی، میزان شلیک یک نوروں UJT را افزایش داد. این رفتار نشان دهنده اتصال تحریکی بین دو نوروں است.

---